

Tensioned Hold Down Installation Method on Sheetrock

Please Note: Use wood blocking and appropriate weight bearing fasteners (*provided by others*) if mounting to sheetrock.

Dual Roller Outside/Face Mount

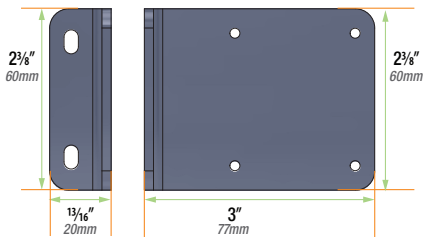
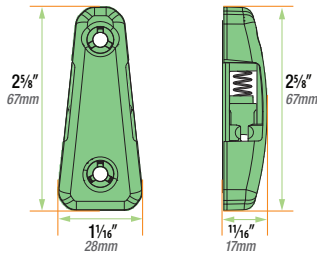
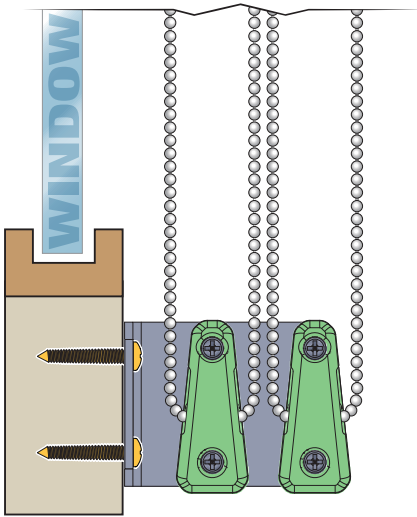

Dual Roller Side/Wall Mount

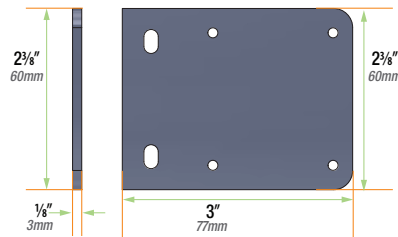
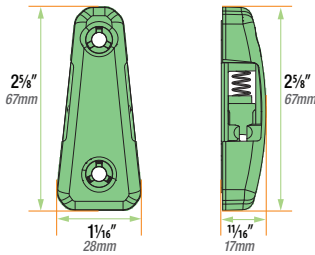
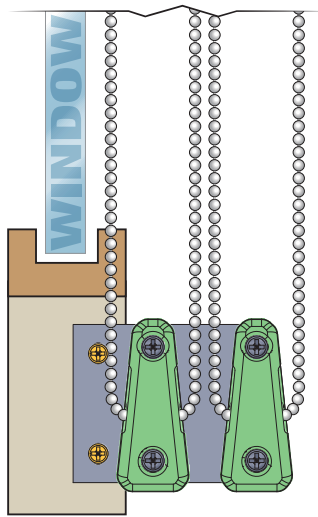

Dual Roller Sill/Floor Mount

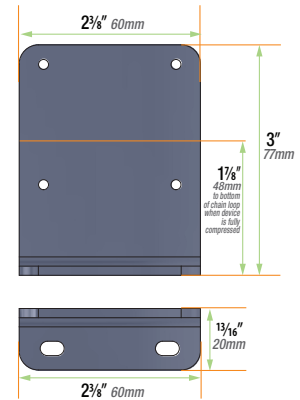
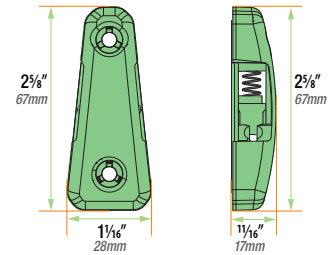
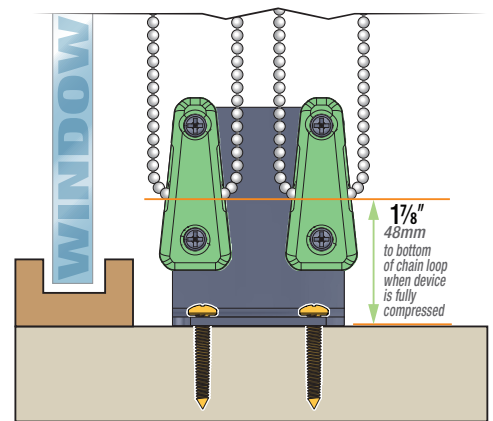

Please Note: Dual Roller Outside/Face Mount and Dual Roller Sill/Floor Mount use the same mounting bracket.