

Gym Equipment Key Switches

SPECIFICATIONS AND SUBMITTAL

Specifications - Gym Equipment Key Switches

Draper gymnasium equipment products are controlled with momentary contact, 3 position (on-off-on) flush mount key switches. Switches are spring loaded to automatically return to the off position. UL recognized switches are rated at 25 amps, up to 277 volts and 1 HP at 125 volts. Switches are mounted on stainless steel cover plates and extend no more than ¼" beyond cover plate. Draper Gym Equipment Key Switches should only be used with instantly reversing motors and should be mounted in a position so that the user has full view of equipment during operation.

When used in conjunction with a standard wall switch box (provided by others), the switches on this cover plate meet the requirements for NEMA ICS Standard for a Type 1 Enclosure. Type 1 enclosures are designed for indoor use and intended to provide a degree of personal protection against access to electrical parts and to lightly protect inside components against dust and/or indirect splashing.

Standard practice is to provide individual key switches for every winch, divider curtain or height adjuster to be operated, but multi-ganged switches are available up to seven ganged switches.

Wiring of all electrical components to be in accordance with local electrical codes and in accordance with manufacturer's instructions. All conduit, wiring, electrical boxes and components not indicted above are to be supplied and installed by the electrical contractor. Single switches require a standard switch box that measures 3" (h) x 2¼" (w) x 2½" (d). Ganged switches require switch boxes that measure 3" (h) x 1 7/8" times number of switches (w) [See Table on Page 2] and 2½" (d).

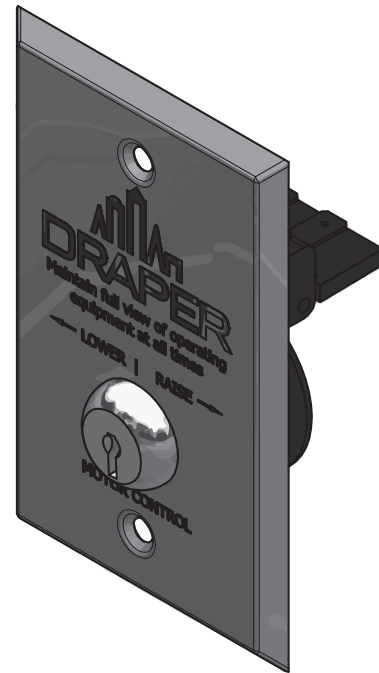

Please Mark Appropriate Selections

- C112.135 Standard Individual Gym Equipment Key Switch
- C112.136 Two Gang Gym Equipment Key Switch
- C112.137 Three Gang Gym Equipment Key Switch
- C112.138 Four Gang Gym Equipment Key Switch
- C112.139 Five Gang Gym Equipment Key Switch
- C112.140 Six Gang Gym Equipment Key Switch
- C112.141 Seven Gang Gym Equipment Key Switch

See reverse side for switch details.

Wiring Diagram

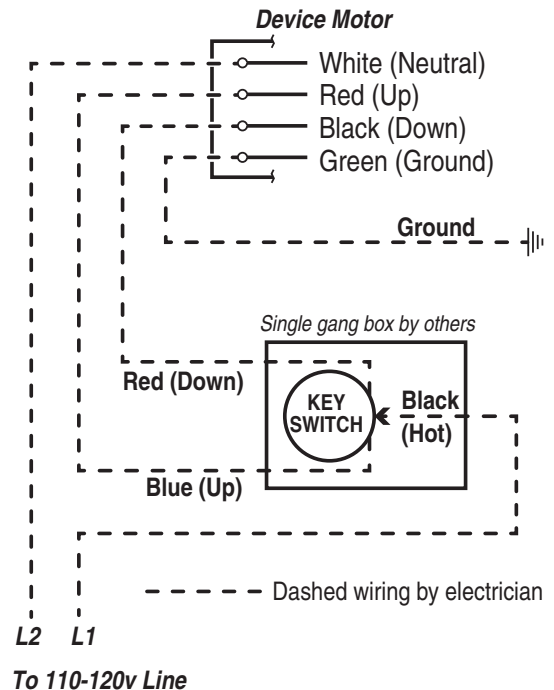

Draper, Inc. | 411 S. Pearl St. Spiceland, IN 47385
draperinc.com | 765.987.7999 | 800.238.7999

© 2018 All Rights Reserved | FORM: GymKeySwitches_Sub18

PROJECT: _____

ARCHITECT: _____

CONTRACTOR: _____

SUPPLIER: _____

DATE: _____ REVISED: _____

Key Switch Dimensions

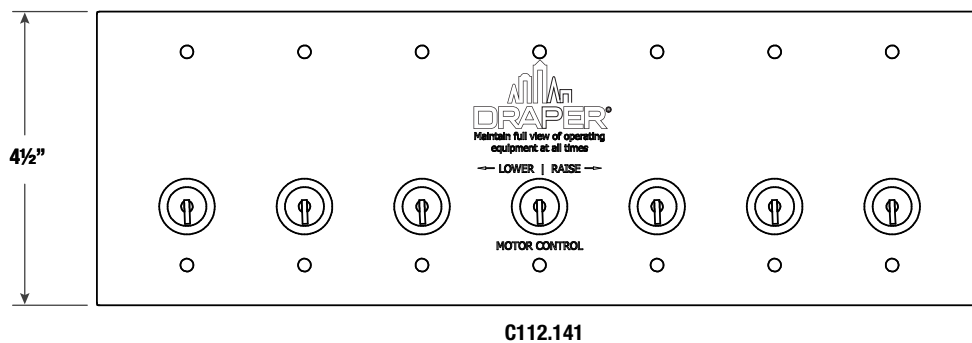
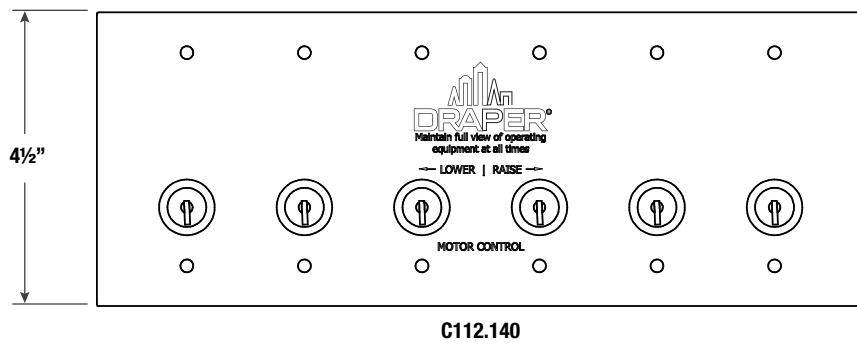
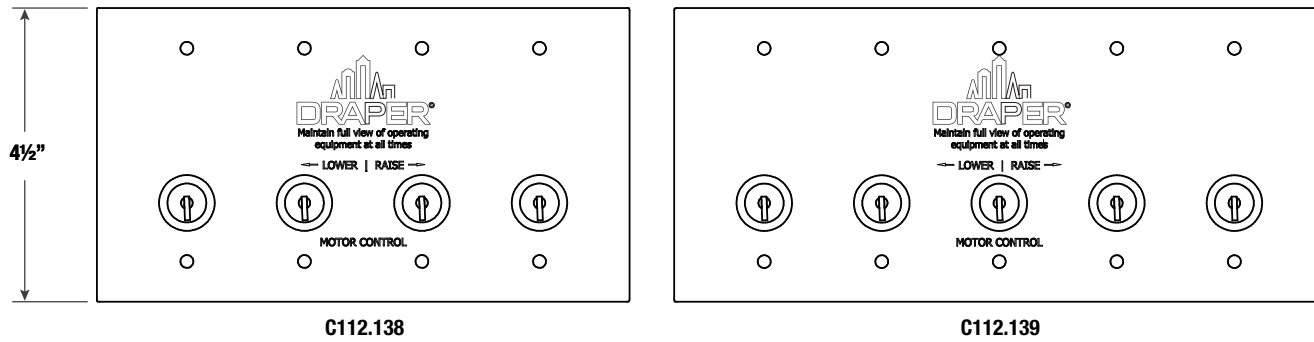
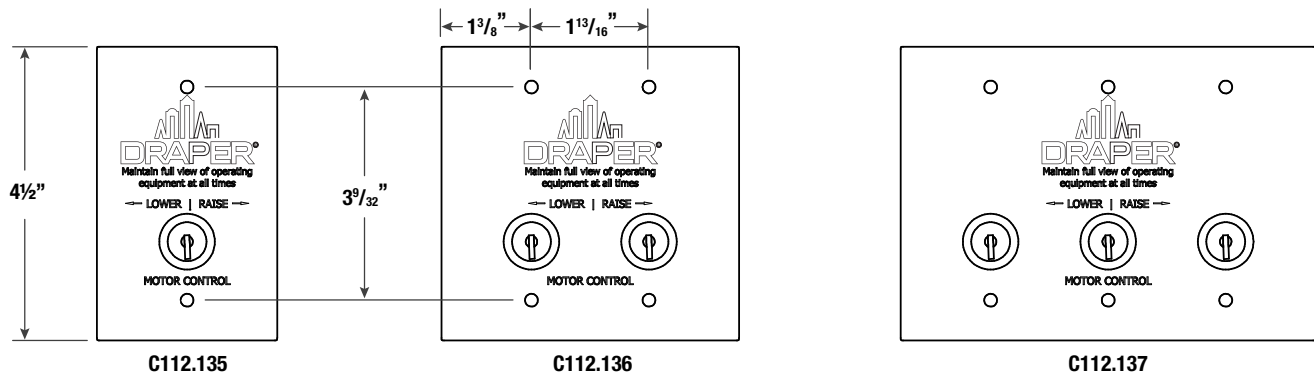

Side View of All

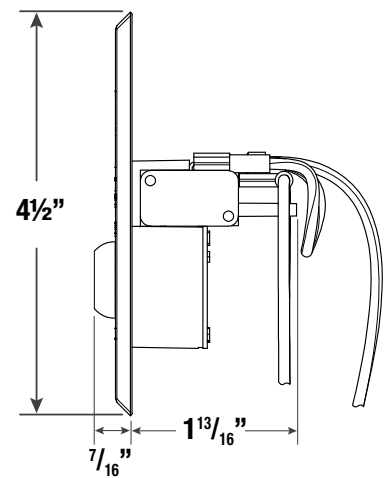

Electrical Device Box (by Others)

Part #	Switch Box Width
C112.135	2 1/4"
C112.136	3 3/4"
C112.137	5 5/8"
C112.138	7 1/2"
C112.139	9 3/8"
C112.140	11 1/2"
C112.141	13 1/8"

